

Linear

LINI-S R014

Fixture Guide

KKDÖ

Indoor | Surface | Output up to 1158lm/m (353lm/ft)



Key applications

- ✓ Architectural detail
- ✓ Cabinet & furniture
- ✓ Cove lighting
- ✓ Display case
- ✓ Indirect lighting
- ✓ Interior
- ✓ Mirror back lighting
- ✓ Retail display
- ✓ Shelving display

Key features

- ✓ Custom lengths
- ✓ Constant Voltage (CV)
- ✓ Diffusion: homogenous
- ✓ Direct view
- ✓ Extensive CCT range
- ✓ IP40 dry area
- ✓ IP44 moisture resistant
- ✓ Light on time (10 day delivery)

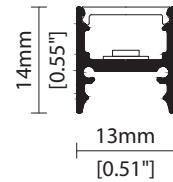

MOUNTING METHODS



KKCP-10 Concealed clip

Linear

LINE-S R014

Specification sheet



Dimensions	H14/W13/L97-2014mm (H0.55/W0.51/L3.81-79.29in)
PCB Cut-point	41.7mm increment/2000mm max (1.64in increment/78.74in max)
LED Pitch	6.95mm-144LED/m (0.27in - 44LED/ft)
Chip	s-line k-line
Cover/Optics	Clear (105°)/Diffused (110°)
CCT	s-line: 1900K/2100K/2300K/2500K/2700K/3000K/3500K/4000K/5000K Single colours: Red/Green/Blue/Orange/Amber k-line: 1900K/2100K/2300K/2500K/2700K/3000K/3500K/4000K/5000K
LED binning	s-line: 2-step MacAdam ellipse k-line: 3-step MacAdam ellipse
CRI	≥92
Lifetime	50,000 hours @ 25°C (50,000 hours @ 77°F)
Operating temp	T _a = -25 to 50°C (T _c max = 73°C) T _a = -13 to 122°F (T _c max = 163°F)
IP Rating	IP40/IP44
Finish	Silver anodised
Mounting	Surface mounting via concealed clips
Power feed	Hardwire tails or male/female connectors
Control	0-10V/1-10V/DMX/DALI



LED Grading Key

Exclusive Grade

s s-line*	*KKDC tuned CCT range
2-step CCT range	

Base Grade

k k-line	3-step commercial range Energy Star CCTs
------------------------	---

Power consumption	Supply voltage	Supply current
14W/m (4.27W/ft)	24V DC	0.58A/m (0.18A/ft)

Performance Data (3000K)

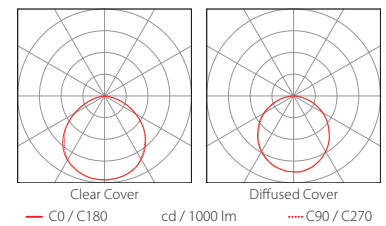
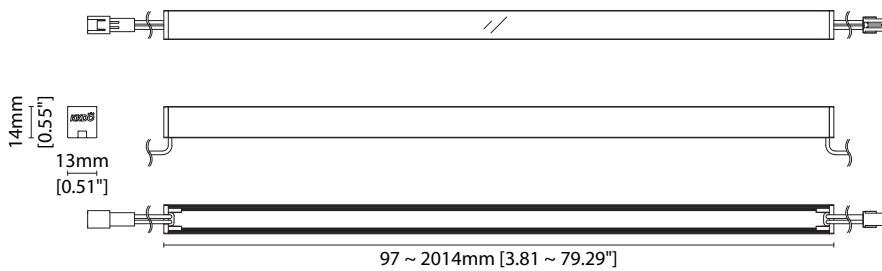

	R1	R2	R3	R4	R5	R6	R7	R8	R9	R10	R11	R12	R13	R14
k-line	92	96	97	91	91	94	92	83	63	90	91	73	93	98

	Clear Cover	Diffused Cover	CRI	R9	Rf	Rg
s-line	1158lm/m (353lm/ft) 82.7lm/W	876lm/m (267lm/ft) 62.5lm/W	93	64	-	-
k-line	1092lm/m (333lm/ft) 78lm/W	826lm/m (252lm/ft) 59lm/W	92	63	-	-



Data derived from independent UKAS/IESNA LM-79-08 accredited testing of production samples.

FIXTURE

Model	Finish ¹	Cover ²	Grade ³	LED	Colour (CCT)	Length Availability ⁴	IP	Cable Length	Power Feed ⁵	Input										
LINI-S	LS	Silver Anodised (grey endcaps)	SA	Clear	B	 s	R014 R014	1900K	19	m 97.4-2014mm 41.7mm increments	IP40 40 IP44 44	50mm/1.97" 0050 300mm/11.81" 0300 1000mm/39.37" 1000	Single no sheath tail S00X DC 24V							
			Diffused	C	 k		2100K	21												
	Silver Anodised (white endcaps)	SAWE																		
																			2300K	23
																			2500K	25
																			2700K	27
																			3000K	30
																			3500K	35
																			4000K	40
																			5000K	50
																			RED	RED  only
																			GREEN	GRN
	BLUE	BLU																		
	ORANGE	ORN																		
AMBER	AMB																			

¹ Refer to **End Cap Options** on **Options** pages

² Refer to **Cover/Lens Options** on **Options** page

³ Refer to **LED Grading Key** on **Specification sheet** page

⁴ Refer to **Length Availability List** or enter total run length instead of length code

⁵ Refer to **Power Feed Options** on **Options** pages

Code Example:

LS	-	SA	-	C	-	s	-	R014	-	35	-	m	514	-	40	-	0300	-	D00X	-	g
LINI-S		Silver Anodised (grey endcaps)		Diffused				R014		3500K		514mm		IP40		300mm/11.81"		Double no sheath tail		DC 24V	

ACCESSORIES

Mounting Accessories

KKCP-10 Concealed Clip

* Refer to **Mounting accessories** on **Accessories** pages

Connection Accessories

KKCN-01 2 PIN male & female 50mm (1.97in) pair

KKCN-03 2 PIN male & female 300mm (11.81in) pair

KKCN-06 2 PIN 300mm (11.81in) extension lead

* Refer to **Power feed** on **Accessories** pages

PSU/Driver

0-10V/1-10V/DALI/DMX

* Refer to **Driver/PSU Options** page for details or provide requirement and KKDC to offer the suitable option

LED ENGINE VARIANTS (LED STRIP TYPE)

Colour	LED	Lumen/m	Lumen/ft	W/m	W/ft	Spec Doc	Length	Increment
Single CCT	R007	564	172	7	2.13	LINI-S R007	97-2014mm (3.81-79.29in)	41.7mm (1.64in)
	R014	1158	353	14	4.27	LINI-S R014	97-2014mm (3.81-79.29in)	41.7mm (1.64in)
Warm Dim/Dynamic White	R020	1632	498	20	6.10	LINI-S R020	97-2014mm (3.81-79.29in)	41.7mm (1.64in)
	R207	1323	403	16	4.88	LINI-S R207	97-2014mm (3.81-79.29in)	83.3mm (3.28in)
RGB	501	Red: 134 Green: 284 Blue: 46 RGB: 423	Red: 41 Green: 87 Blue: 14 RGB: 129	15.6	4.75	LINI-S RGB	97-2014mm (3.81-79.29in)	83.3mm (3.28in)

* Performance data: s-line, 3000K, clear cover

LINE-S R014

Length Availability List



Length Code		Fixture Length ¹		LED Strip ²		End Cap Dimension		Wattage (W)	Output (lm)
Metric	Imperial(US)	Metric	Imperial(US)	Metric	Imperial(US)	Metric	Imperial(US)		3000K (Test Data)
m0097	i0004	97mm	3.83in	83mm	3.28in	4mm	0.16in	1.17	91
m0139	i0005	139mm	5.47in	125mm	4.92in	4mm	0.16in	1.75	137
m0181	i0007	181mm	7.11in	167mm	6.56in	4mm	0.16in	2.33	182
m0222	i0009	222mm	8.75in	208mm	8.20in	4mm	0.16in	2.92	227
m0264	i0010	264mm	10.39in	250mm	9.84in	4mm	0.16in	3.50	273
m0306	i0012	306mm	12.03in	292mm	11.48in	4mm	0.16in	4.08	318
m0347	i0014	347mm	13.67in	333mm	13.12in	4mm	0.16in	4.67	364
m0389	i0015	389mm	15.31in	375mm	14.76in	4mm	0.16in	5.25	409
m0431	i0017	431mm	16.96in	417mm	16.40in	4mm	0.16in	5.83	455
m0472	i0019	472mm	18.60in	458mm	18.04in	4mm	0.16in	6.42	500
m0514	i0020	514mm	20.24in	500mm	19.69in	4mm	0.16in	7.00	546
m0556	i0022	556mm	21.88in	542mm	21.33in	4mm	0.16in	7.58	591
m0597	i0024	597mm	23.52in	583mm	22.97in	4mm	0.16in	8.17	637
m0639	i0025	639mm	25.16in	625mm	24.61in	4mm	0.16in	8.75	682
m0681	i0027	681mm	26.80in	667mm	26.25in	4mm	0.16in	9.33	728
m0722	i0028	722mm	28.44in	708mm	27.89in	4mm	0.16in	9.92	773
m0764	i0030	764mm	30.08in	750mm	29.53in	4mm	0.16in	10.50	819
m0806	i0032	806mm	31.72in	792mm	31.17in	4mm	0.16in	11.08	864
m0847	i0033	847mm	33.36in	833mm	32.81in	4mm	0.16in	11.67	910
m0889	i0035	889mm	35.00in	875mm	34.45in	4mm	0.16in	12.25	955
m0931	i0037	931mm	36.64in	917mm	36.09in	4mm	0.16in	12.83	1001
m0972	i0038	972mm	38.28in	958mm	37.73in	4mm	0.16in	13.42	1047
m1014	i0040	1014mm	39.92in	1000mm	39.37in	4mm	0.16in	14.00	1092
m1056	i0042	1056mm	41.56in	1042mm	41.01in	4mm	0.16in	14.58	1137
m1097	i0043	1097mm	43.20in	1083mm	42.65in	4mm	0.16in	15.17	1183
m1139	i0045	1139mm	44.84in	1125mm	44.29in	4mm	0.16in	15.75	1228
m1181	i0046	1181mm	46.48in	1167mm	45.93in	4mm	0.16in	16.33	1274
m1222	i0048	1222mm	48.12in	1208mm	47.57in	4mm	0.16in	16.92	1319
m1264	i0050	1264mm	49.76in	1250mm	49.21in	4mm	0.16in	17.50	1365
m1306	i0051	1306mm	51.40in	1292mm	50.85in	4mm	0.16in	18.08	1410
m1347	i0053	1347mm	53.04in	1333mm	52.49in	4mm	0.16in	18.67	1456
m1389	i0055	1389mm	54.69in	1375mm	54.13in	4mm	0.16in	19.25	1501
m1431	i0056	1431mm	56.33in	1417mm	55.77in	4mm	0.16in	19.83	1547
m1472	i0058	1472mm	57.97in	1458mm	57.41in	4mm	0.16in	20.42	1592
m1514	i0060	1514mm	59.61in	1500mm	59.06in	4mm	0.16in	21.00	1638
m1556	i0061	1556mm	61.25in	1542mm	60.70in	4mm	0.16in	21.58	1683
m1597	i0063	1597mm	62.89in	1583mm	62.34in	4mm	0.16in	22.17	1729
m1639	i0065	1639mm	64.53in	1625mm	63.98in	4mm	0.16in	22.75	1774
m1681	i0066	1681mm	66.17in	1667mm	65.62in	4mm	0.16in	23.33	1820
m1722	i0068	1722mm	67.81in	1708mm	67.26in	4mm	0.16in	23.92	1865
m1764	i0069	1764mm	69.45in	1750mm	68.90in	4mm	0.16in	24.50	1911
m1806	i0071	1806mm	71.09in	1792mm	70.54in	4mm	0.16in	25.08	1956
m1847	i0073	1847mm	72.73in	1833mm	72.18in	4mm	0.16in	25.67	2002

LINI-S R014

Length Availability List



Length Code		Fixture Length ¹		LED Strip ²		End Cap Dimension		Wattage (W)	Output (lm) 3000K (Test Data)
Metric	Imperial(US)	Metric	Imperial(US)	Metric	Imperial(US)	Metric	Imperial(US)		
m1889	i0074	1889mm	74.37in	1875mm	73.82in	4mm	0.16in	26.25	2047
m1931	i0076	1931mm	76.01in	1917mm	75.46in	4mm	0.16in	26.83	2093
m1972	i0078	1972mm	77.65in	1958mm	77.10in	4mm	0.16in	27.42	2138
m2014	i0079	2014mm	79.29in	2000mm	78.74in	4mm	0.16in	28.00	2184

¹ Actual total overall length of light fixture (LED strip + end caps + void/wire hole)

² Actual length of PCB strip

³ Actual length of 2x end caps

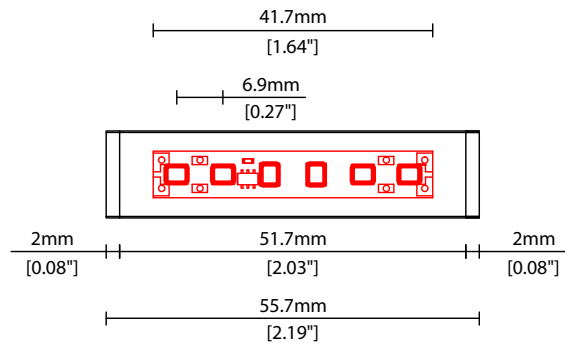

COVER/LENS OPTIONS

* Options are an integral part of the fixture ordering codes. Please refer to **Code Table** pages.

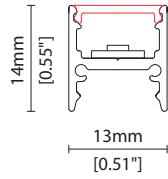

B Clear cover
W13/H14(W0.51/H0.55in)

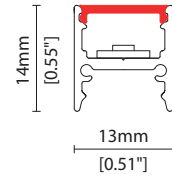

C Diffused cover
W13/H14(W0.51/H0.55in)

END CAP OPTIONS



SA Silver anodised finish
with grey end caps.

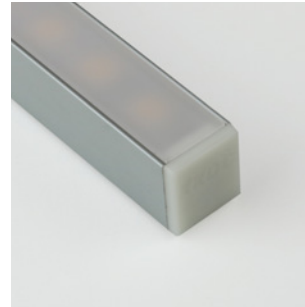

SAWE Silver anodised finish
with white end caps.

POWER FEED OPTIONS

0050 S20X 50mm (1.97") Single no sheath IP20 connector

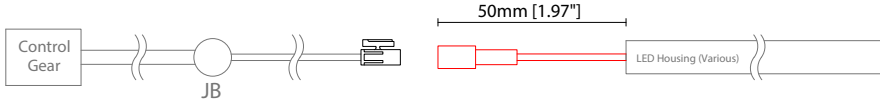

0050 D20X 50mm (1.97") Double no sheath IP20 connector

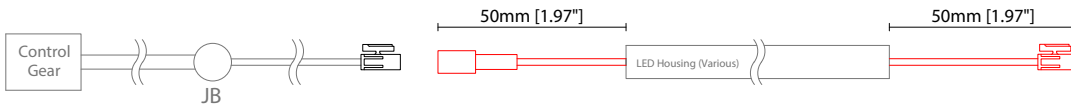

0300 S00X 300mm (11.81") Single no sheath tail

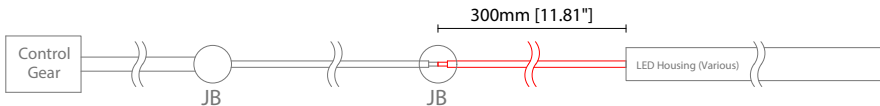

0300 D00X 300mm (11.81") Double no sheath tail

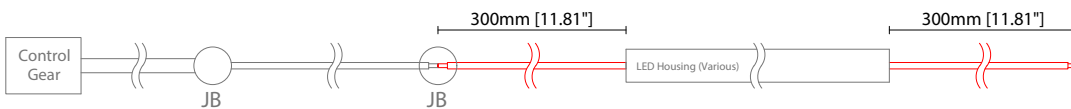

0300 S20X 300mm (11.81") Single no sheath IP20 connector

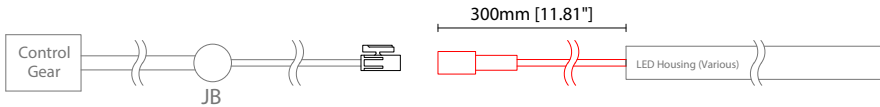

0300 D20X 300mm (11.81") Double no sheath IP20 connector

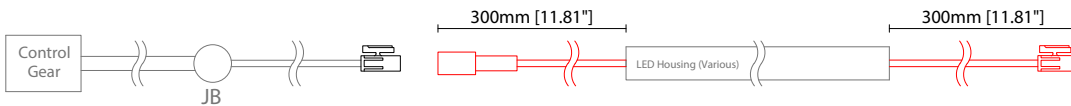

1000 S00X 1000mm (39.37") Single no sheath tail

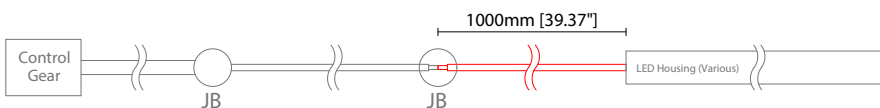

1000 D00X 1000mm (39.37") Double no sheath tail

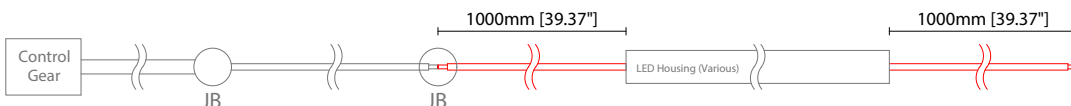

1000 S20X 1000mm (39.37") Single no sheath IP20 connector

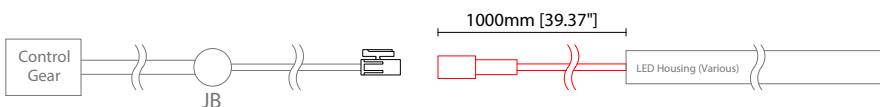

Key

Control Gear Power supply, sub-controllers & control systems

JB Junction box / cable connection

POWER FEED OPTIONS (CONTINUED)

1000 D20X 1000mm (39.37") Double no sheath IP20 connector

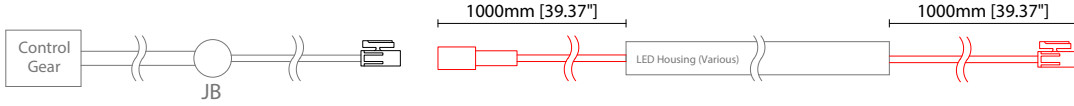

2 Pin Female Connector

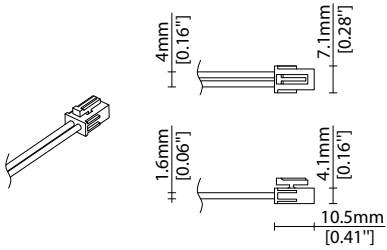

2 Pin Male Connector

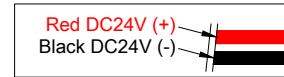
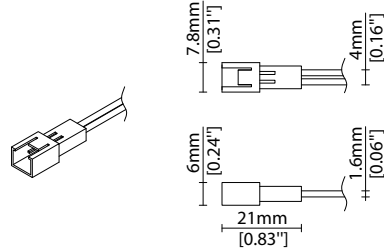

Key

Control Gear Power supply, sub-controllers & control systems
 JB Junction box / cable connection

MOUNTING ACCESSORIES

Note: Accessories are to be ordered separately with corresponding code shown below.

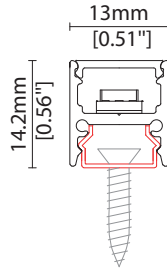

KKCP-10

Concealed clip
(allow 3 per metre/40in)
S/Steel finish
L20/W13/H14.2mm
(L0.79/W0.51/H0.56")

POWER FEED

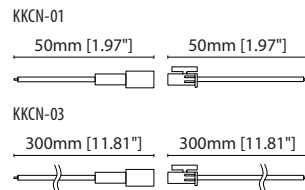
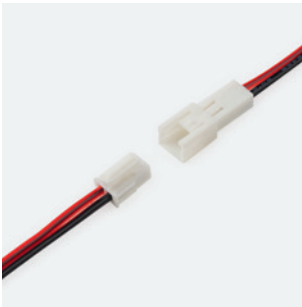

KKCN-01 50mm (1.97in) pair

KKCN-03 300mm (11.81in) pair

2 PIN male + female connector set

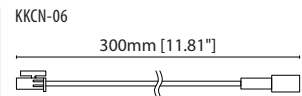

KKCN-06

2 PIN 300mm (11.81in) extension lead

KKDC CONTROL



IP20
Plastic housing
L170/W59/H29mm
(L6.69/W2.32/H1.14in)

KKDM-06 1-10V
visDIM dimmable sub-controller
(4 x 8A max @ 12-36V)



IP20
Plastic housing
L170/W53.4/H28mm
(L6.69/W2.10/H1.10in)

KKSC-05 DMX
visDIM dimmable sub-controller
(4 x 5A max @ 12-36V)



IP20
Plastic housing
L170/W59/H29mm
(L6.69/W2.32/H1.14in)

KKDL-02 DALI
visDIM dimmable sub-controller
(4 x 8A max @ 12-36V)



IP20
Plastic housing
L166/W53.4/H23mm
(L6.54/W2.10/H0.91in)

KKDL-03 DALI
visDIM dimmable sub-controller
(4 x 5A max @ 12-36V)



IP20
Plastic housing
L170/W53.4/H28mm
(L6.69/W2.10/H1.10in)

KKDL-04 DALI-2
visDIM dimmable sub-controller
(4 x 5A max @ 12-36V)

AVAILABLE PSU OPTIONS

Control Mode	PSU (Order Code)	Input Voltage AC	Output Voltage DC	Rated Output Current	Rated Power	Dim %	IP Rating
Switched	CEN-60-24	90-295V	24V	2.5A	60W	-	IP67
	HLG-60H-24	90-305V	24V	2.5A	60W	-	IP67
	HLG-100H-24	90-305V	24V	4.0A	100W	-	IP67
	HLG-150H-24	90-305V	24V	6.3A	150W	-	IP67
	HLG-240H-24	90-305V	24V	10A	240W	-	IP67
0-10V (1-10V)	PWM-40-24	90-305V	24V	1.67A	40W	100-0.15 (100-10)	IP67
	PWM-60-24	90-305V	24V	2.5A	60W	100-0.15 (100-10)	IP67
	PWM-90-24	90-305V	24V	3.67A	90W	100-0.15 (100-10)	IP67
	PWM-120-24	90-305V	24V	5.0A	120W	100-0.15 (100-10)	IP67
DALI	LIN100A1	120-277V	24V	1A per channel	100W	100-0.1	IP66/IP40
DMX RGB	LIN100A1	120-277V	24V	1.33A per channel	100W	100-0.1	IP66/IP40
DMX RGBW	LIN100A1	120-277A	24V	1A per channel	100W	100-0.1	IP66/IP40

Flicker Free Options - Combination of PSU+ sub-controller

Control Mode	PSU (Order Code)	Sub-controller (Order Code)	Input Voltage AC	Output Voltage DC	Rated Output Current	Rated Power	Dim %	IP Rating PSU/ Sub-controller
0-10V or 1-10V	CEN-60-24	KKDM-06	90-295V	24V	2.5A	60W	100-0.9	IP67/IP20
	HLG-60H-24	KKDM-06	90-295V	24V	2.5A	60W	100-0.9	IP67/IP20
	HLG-100H-24	KKDM-06	90-295V	24V	4.0A	100W	100-0.9	IP67/IP20
	HLG-150H-24	KKDM-06	90-295V	24V	6.3A	150W	100-0.9	IP67/IP20
	HLG-240H-24	KKDM-06	90-295V	24V	10.0A	240W	100-0.9	IP67/IP20
DALI	CEN-60-24	KKDL-02/03/04/visDIM PRO 30	90-295V	24V	2.5A	60W	100-0.1	IP67/IP20
	HLG-60H-24	KKDL-02/03/04/visDIM PRO 30	90-305V	24V	2.5A	60W	100-0.1	IP67/IP20
	HLG-100H-24	KKDL-02/03/04/visDIM PRO 30	90-305V	24V	4.0A	100W	100-0.1	IP67/IP20
	HLG-150H-24	KKDL-02/03/04/visDIM PRO 30	90-305V	24V	6.3A	150W	100-0.1	IP67/IP20
	HLG-240H-24	KKDL-02/03/04/visDIM PRO 30	90-305V	24V	10.0A	240W	100-0.1	IP67/IP20
DMX RGB	CEN-60-24	KKSC-05	90-295V	24V	2.5A	60W	100-0.9	IP67/IP20
	HLG-60H-24	KKSC-05	90-305V	24V	2.5A	60W	100-0.9	IP67/IP20
	HLG-100H-24	KKSC-05	90-305V	24V	4A	100W	100-0.9	IP67/IP20
	HLG-150H-24	KKSC-05	90-305V	24V	6.3A	150W	100-0.9	IP67/IP20
	HLG-240H-24	KKSC-05	90-305V	24V	10.0A	240W	100-0.9	IP67/IP20

¹ The items shown above cover the most frequently used specification but does not exhaust the possible options

² PSU and/or driver can be chosen from the table, or KKDC may recommend the best option upon receipt of the controls requirement and installation environment

³ Electrical shop drawing will include detailed information of PSU and relevant control drivers

⁴ Cut sheets are available on the controls section of www.kkdc.lighting or upon request